

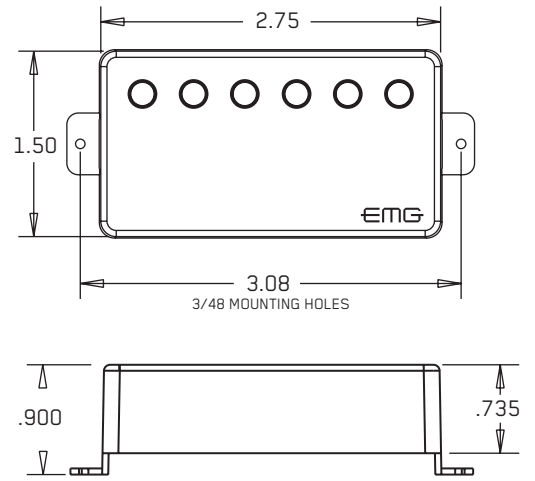

01230-XXXX

PO BOX 4394
SANTA ROSA, CA
95402 USA

P (707) 525-9941
F (707) 575-7046
EMGPICKUPS.COM



INSTALLATION INFORMATION

EMG MODEL: 66 PICKUP

SPECIFICATIONS:

Logo Color*
Magnet Type**
Resonant Frequency (KHz)
Output Voltage (String)
Output Voltage (Strum)
Output Noise (60 Hz)
Output Impedance (Kohm)
Current @9V (Microamps) (Set)
Battery Life (Hours)(Set)
Maximum Supply (Volts DC) (Set)

MODEL:

66
White
A
1.61
3.00
4.50
-100
10
160
1500
27

*Note: Logo Color is not distinguished on the 66 Pickup

**Note: Magnet Type: A (Alnico)

INSTALLATION NOTES:

All EMG Pickups are compatible with each other. The connector system is an easy method of installation, avoiding the need to solder. EMG accessories like the VLPF, EXG, SPC or RPC Controls can be added to any EMG Pickup System without the need for an extra battery.

IMPORTANT INSTALLATION NOTES:

- 1) Only one 9-Volt battery is required to power the pickups and any accessories such as the SPC, RPC, EXG, AB, PA-2, and Pi-2. Use an Alkaline or Lithium battery for longest life.
- 2) The Volume and Tone Controls included with this EMG System are 25K Ohm. This value is required for the system to work correctly.
- 3) A stereo output jack (12B) is included with the EMG Pickups; it grounds the black battery wire to turn on the pickups when the plug is inserted into the jack. If you are replacing passive pickups, make sure to use the jack included. If your guitar has a long panel jack (see Page 3, bottom), make sure it is a stereo type, a Switchcraft 152B is recommended.
- 4) When installing EMG Active Pickups, DO NOT connect the bridge ground wire. This wire is usually soldered to a Volume or Tone Control casing and goes to the bridge. This wire grounds the strings and uses them and your body as a shield against hum and buzz. It also creates a shock hazard.

EMG Pickups are shielded internally and DO NOT require string grounding. This greatly reduces the possibility of reverse polarity shock from microphones and other equipment.

- 5) EMG Active Pickups have very little magnetism compared to passive pickups. We recommend you adjust the pickups as close to the strings as possible. Sustain and string movement will not be inhibited by close adjustment.
- 6) If your installation is different from the diagrams in these instructions or you need additional diagrams visit our website: emgpickups.com for a complete listing of available diagrams.

7) SPECIAL NOTE:

The diagrams shown are for EMG Active Pickups. All diagrams show the Red Wire coming from the pickups connected to the battery. If you are installing EMG-HZ Passive Pickups refer to their diagrams. The Red Wire of the HZ Pickup is NOT for battery power, it is a coil wire.

WARRANTY

All EMG Pickups and accessories are warranted for a period of two years. This warranty does not cover failure due to improper installation, abuse or damage. If upon examination the pickup is determined to be defective, a replacement will be made. Warranty replacement products are covered by this same warranty. This warranty covers only those pickups and accessories sold by authorized EMG Dealers. This warranty is not transferable.

Installation Instructions: EMG Models: EMG-66 Pickup

General Notes:

- Every attempt has been made to make this a solderless installation. There are some instances where this is not possible;
- 1) If your instrument uses the long panel output jack and you had passive pickups you will need a new stereo output jack, the Switchcraft 152B is recommended. Soldering to the new jack will be required, see diagram #6.
 - 2) Some instruments may already have a battery holder installed and in that case see the diagram at the bottom of page 3.
 - 3) Instruments with two pickups may need soldering to the selection switch in some installations.

Installation (Two Pickup Guitars with Selection switch):

Guitars with two pickups and a selection switch will use the EMG B157 Pickup Buss as shown in diagram #2.

The Pickup Buss is a convenient way to wire your guitar without soldering.

There is a separate sheet attached to these instructions that describes the B157 Pickup Buss in detail.

In all installations it's best to find a place to mount the Pickup Buss in the control cavity before starting. Then, after the cables are routed use the velcro to mount it securely.

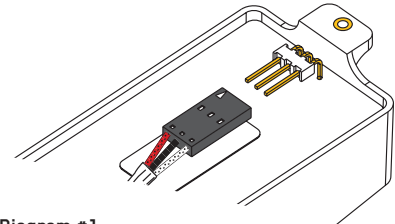

Diagram #1

Insert the plug onto the 3 pin header of the pickup as shown above. Note the orientation arrow.

2 Pickups / Toggle Select Switch / Master Volume and Tone

Refer to Diagrams #1, #2, and #3

- 1) Install the Pickups and route the Pickup cables to the control cavity. If the cables are too long, wind up the excess and keep it under the pickup.
- 2) Mount the Volume and Tone controls into the body. Plug both Pickup cables onto the B157 Pickup Buss (BLACK Shroud) as shown. Refer to diagram #2
Bridge Pickup to position 1
Neck Pickup to position 2.
- 3) Plug a coax cable from the Pickup Buss (position 3) to the Master Volume control as shown in diagram #3.
- 4) Plug a coax cable from the Master Volume to the Master Tone as shown.
- 5) Strip the insulation from the switch wires and Insert them into the GREEN Terminal Block and tighten the screws with a small screwdriver.
The Bridge pickup goes to the BR Terminal
The Neck pickup goes to the NK Terminal
The Output of the switch goes to the O Terminal
If there is a ground wire coming from the switch, insert it into one of the black terminals on the terminal block.
- 6) Plug the output cable onto the Master Tone control and connect the output wires to the output jack by pushing the connectors on as shown.
WHITE wire onto the TIP (T) contact,
BLACK wire onto the SLEEVE (S) contact
BLACK Battery Negative wire onto the RING (R) contact.

- 7) Plug the RED Wires of the pickups onto the V+ Buss (RED Shroud) along with the RED of the battery clip.
Extra pins on the V+ Buss are for EMG Accessories.
- 8) Put the battery in the insulating foam piece provided and place it securely in the control cavity.
We suggest that you plug in the instrument and test it before closing the control cavity.

Diagram #2

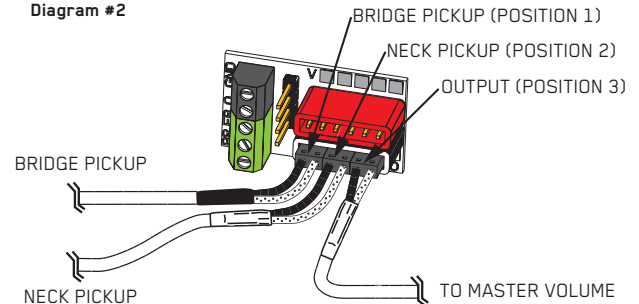

Diagram #3

2 Pickups
Toggle Style Select Switch
Master Volume & Master Tone

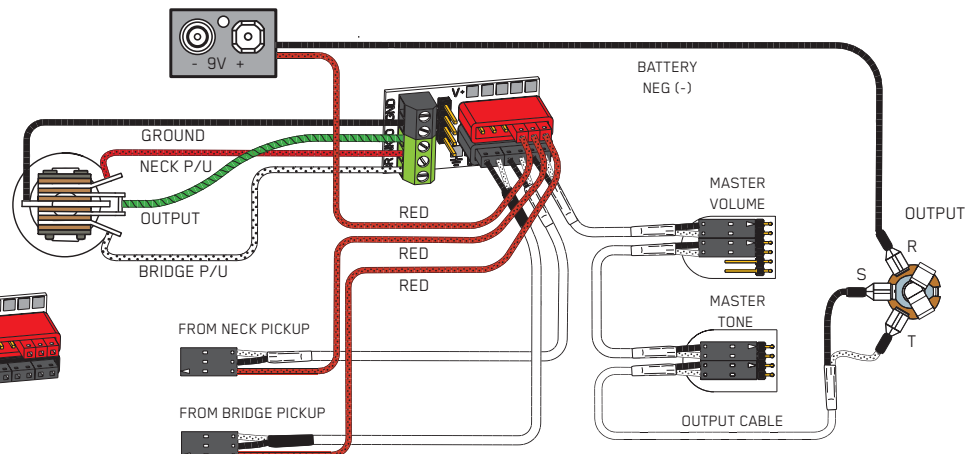
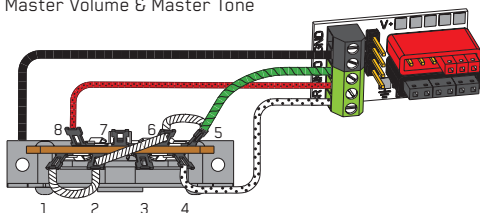

Diagram #3a

2 Pickups
Lever Style Select Switch
Master Volume & Master Tone



****Tips and Tricks****

Start your installation by:

- 1) Read the General Notes on Page 2 if you haven't already and determine if you have the right output jack for your instrument. A Stereo 12B type (Included) or a 152B Long Panel Jack will be required.
- 2) Remove the strings
- 3) Remove any existing Pickups and controls (remember the order and function of each control)
- 4) Determine a good spot for the Pickup Buss and make sure the cable or wires from the selection switch will reach the Pickup Buss,
- 5) Install the EMG Volume and Tone Controls and tighten them in.
- 6) Then install the pickups keeping any excess cable under the pickup rather than in the control cavity.

2 Pickups / Toggle Select Switch / 2 Volumes and Master Tone

Refer to Diagrams #1, #4, and #5

1) Install the Pickups and route the Pickup cables to the control cavity.

If the cables are too long, wind up the excess and keep it under the pickup.

2) Mount the Volume and Tone controls into the body.

Plug both pickup cables onto the Volume controls as shown.

Plug a coax cable from the Bridge Volume control to the Pickup Buss (Position 1)

Plug a coax cable from the Neck Volume control to the Pickup Buss (Position 2)

3) Plug a coax cable from the Pickup Buss (position 3) to the Master Tone control as shown.

4) Strip the insulation from the switch wires and Insert them into the GREEN

Terminal Block and tighten the screws with a small screwdriver.

The Bridge pickup goes to the BR Terminal

The Neck Pickup goes to the NK Terminal

The Output of the switch goes to the O Terminal

If there is a ground wire coming from the switch, insert it into one of the black terminals on the terminal block.

5) Plug the output cable onto the Tone control and connect the wires to the output jack by pushing the connectors on as shown.

WHITE wire onto the TIP (T) contact,

BLACK wire onto the SLEEVE (S) contact

BLACK Battery Negative wire onto the RING (R) contact.

6) Plug the RED Wires of the pickups onto the V+ Supply Buss (RED Shroud) along with the RED of the battery clip. Extra pins are for EMG Accessories.

7) Put the battery in the insulating foam provided and place it securely in the control cavity.

We suggest that you plug in the instrument and test it before closing the control cavity.

Diagram #4

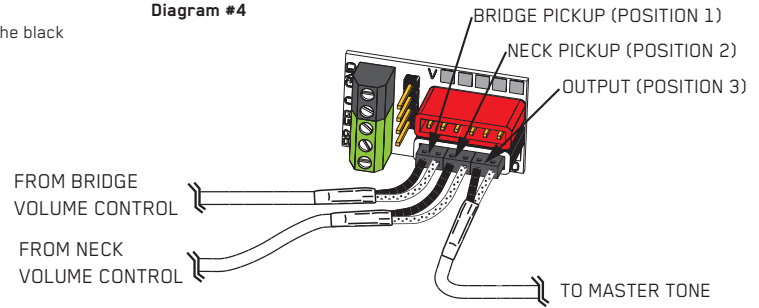

Diagram #5

2 Pickups

Toggle Style Switch

Volume each Pickup (Volumes are independent)

Master Tone

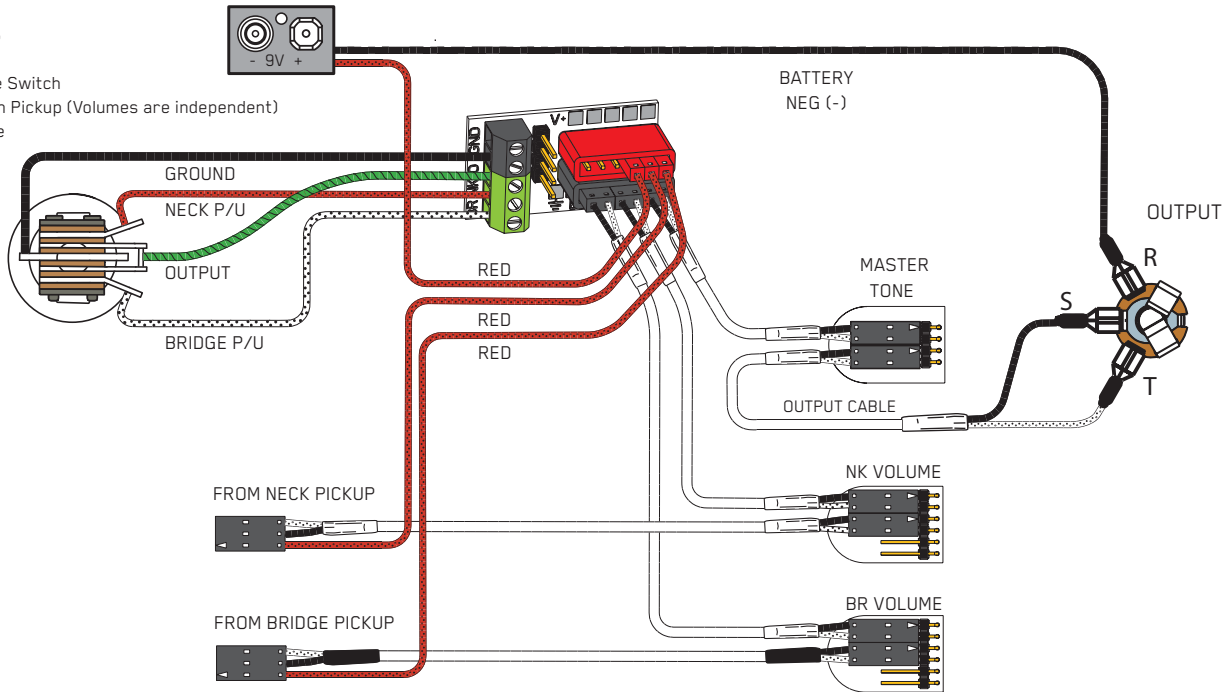

Soldering to the 152B Panel Jack:

If your instrument has a long Panel Jack like the one below you will have to solder the output cable as shown.

Ground (Black) to the sleeve

Signal (White) to the Tip

Battery Negative (Black) to the Ring

Diagram #6

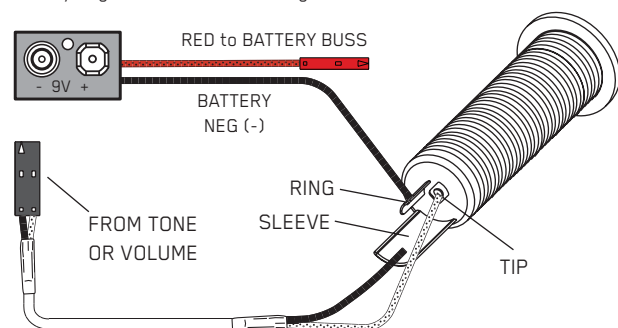

If the instrument has a Battery Holder:

If your instrument has a 9 or 18 Volt battery holder you can still use the EMG Connectors to supply power to the pickups.

Simply cut and strip the wires from the battery clip provided.

Twist the wires together and use the shrink tubing included to cover the connections. Soldering the wires is the preferred.

Cover these connections with the shrink tubing provided.

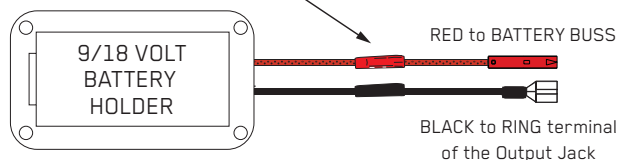

2 Pickups / Toggle Select Switch / 2 Volumes and 2 Tones

Refer to Diagrams #1, #7, and #8

- 1) Install the Pickups and route the cables to the control cavity.
If the cables are too long, wind up the excess and keep it under the pickup.
- 2) Mount the Volume and Tone controls into the body
Plug both Neck and Bridge pickup cables onto the Volume Controls as shown.
Plug a coax cable from the Bridge (BR) Volume control to the Pickup Buss (Position 1). See Diagram #7
Plug a coax cable from the Neck (NK) Volume control to the Pickup Buss (Position 2). See Diagram #7
- 3) Plug a coax cable from the Bridge (BR) Volume control to the Bridge (BR) Tone control as shown.
- 4) Plug a coax cable from the Neck (NK) Volume control to the Neck (NK) Tone control as shown.
- 5) Strip the insulation from the switch wires and insert them into the GREEN Terminal Block and tighten the screws with a small screwdriver.
The Bridge pickup goes to the BR Terminal
The Neck Pickup goes to the NK Terminal
The Output of the switch goes to the O Terminal
If there is a ground wire coming from the switch, insert it into one of the black terminals on the terminal block.

- 6) Plug the output cable onto the Pickup Buss (Position 3) and push the connectors onto the jack as shown.
WHITE wire onto the TIP (T) contact,
BLACK wire onto the SLEEVE (S) contact
BLACK Battery Negative wire onto the RING (R) contact.
- 7) Plug the RED Wires of the pickups onto the V+ Supply Buss (RED Shroud) along with the RED of the battery clip. Extra pins are for EMG Accessories.
- 8) Put the battery in the foam insulator provided and place it securely in the control cavity.
We suggest that you plug in the instrument and test it before closing the control cavity.

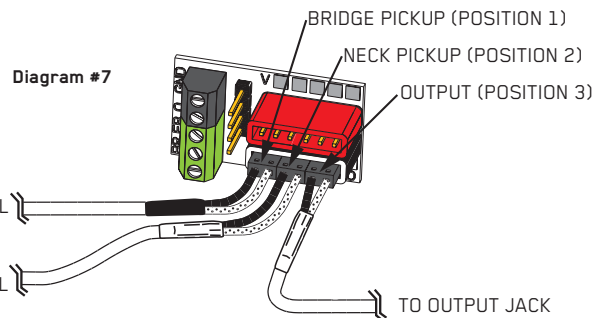
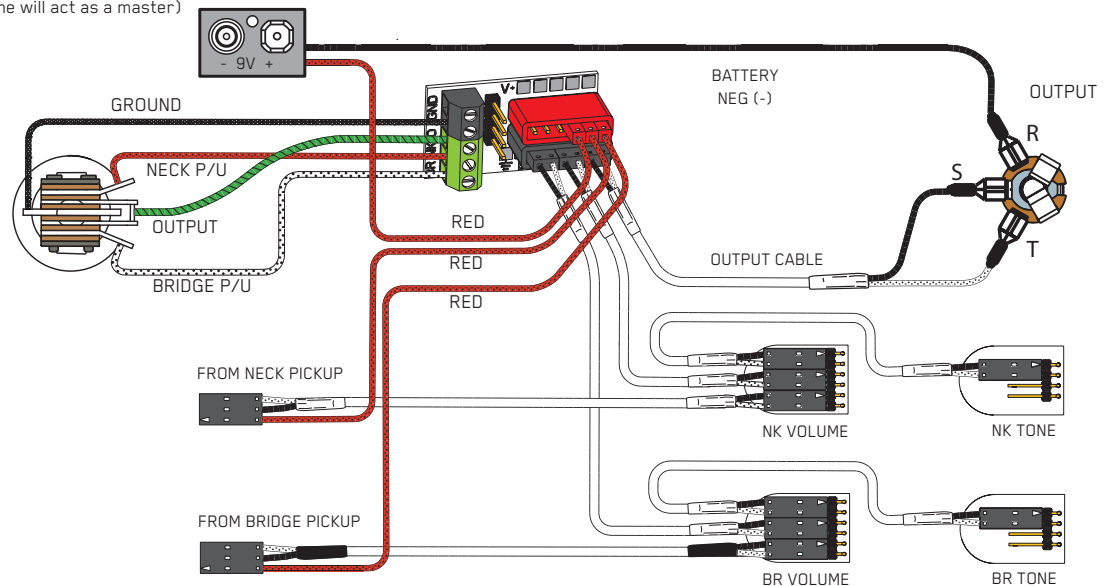

Diagram #8

- 2 Pickups
- 2 Volume (either volume will act as a master)
- 2 Tone
- Toggle Style Switch



Soldering to the In/Out Buss

If you have an older EMG Pickup without the Black connectors you can solder to the pads for pickup inputs. The output can be routed to the jack or to other EMG Accessories, then to the jack.

Diagram #9

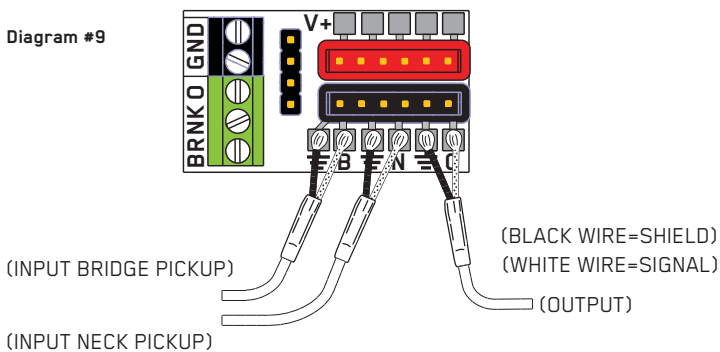

Soldering to the V+ Buss

If you have an older EMG Pickup without the RED V+ connectors you can solder to any of the 5 solder pads to supply voltage to the pickup. Solder the RED of the battery to any one of these pads to supply 9V+.

Diagram #10

