

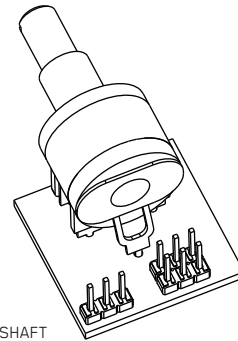

0230-005H

PO BOX 4394
SANTA ROSA, CA
95402 USA

P (707) 525-9941
F (707) 575-7046
EMGPICKUPS.COM



SOLID SHAFT

INSTALLATION INFORMATION

EMG MODEL: B125 ACTIVE BALANCE CONTROL / (ABC) (PASSIVE/ACTIVE PICKUP INPUT)

SPECIFICATIONS

Input Impedance (Ohms)	200K
Input Referred Noise	-130dbV
Output Impedance (Ohms)	2K
Current @ 9V (Microamps)	600
Battery Life (Hours)	750
Maximum Supply (Volts DC)	18

INCLUDED:

- 1 B125 ABC Control
- 1 25K Solid Shaft Pot (Master Volume)
- 1 Active Tone Control (VLPF)
- 1 Battery Clip with Buss Connector
- 1 Stereo Output Jack (Battery Switching)
- 4 Interconnect Cables (2 Red, 2 White)

GENERAL OPERATION

The B125 Active Balance Control (ABC) is used to pan between two EMG-HZ pickups rather than use a selection switch. The B125 features input buffer amps for each pickup, so if you have 2 Passive Pickups, 2 Active EMG Pickups, or are mixing an active with a passive pickup you can use the B125 Active Balance control. Pickups can be connected by connectors or hand soldered to the PC board. The control has a center detent (click) in its rotation.

INSTALLATION NOTES:

The output impedance of the ABC is low, so the existing high resistance volume and tone controls will not work when placed after the ABC. The volume control and active tone control (VLPF) included with the ABC are 25K Ohm. The active tone control (VLPF) is required for tone. Any of the EMG Accessories like the EXB, BTC or BTS Controls, BQC or BQS Controls, or OEM Models B30eq or B64eq will work.

Dimensions: B125 Active Balance (ABC)

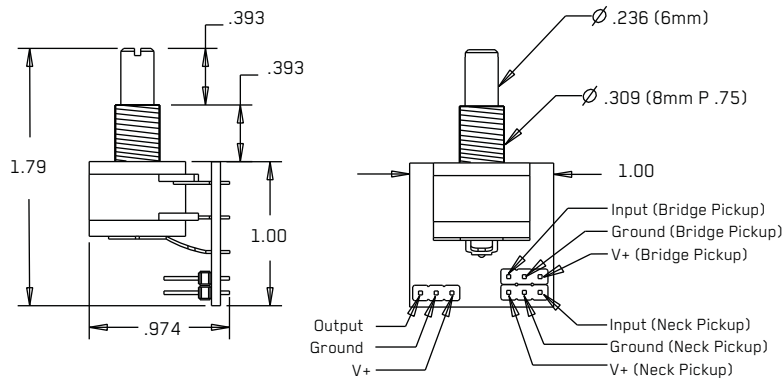

WARRANTY

All EMG Pickups and accessories are warranted for a period of two years. This warranty does not cover failure due to improper installation, abuse or damage. If upon examination the pickup is determined to be defective, a replacement will be made. Warranty replacement products are covered by this same warranty. This warranty covers only those pickups and accessories sold by authorized EMG Dealers. This warranty is not transferable.

Installation Instructions:
EMG Model: B125 ABC (Active Balance Control)

Existing EMG-HZ Passive Pickup installations:

If you already have EMG-HZ Pickups in your instrument you can use the existing pickup cables or you can use the new plug-in cables provided. The new cables are pre-wired to use the pickup in the humbucking mode. If you are using a coil-tap switch, or a phase switch, use the existing cables and use the hand soldered method for installation (see below).

Diagrams 1, 2, and 3 illustrate how to connect the pickups to the ABC Control by using the EMG Plug-in connectors. Diagrams 4, 5, and 6 show how to solder the pickups to the PC Board. The output of the ABC is then illustrated in diagrams on page 4 in a variety of configurations.

Diagram #1
EMG-HZ Plug-in Inputs & Output

Pin 1
 This pin and the one below it supply 9V+ for EMG Active Pickups:
DO NOT use either pin when using passive pickups.

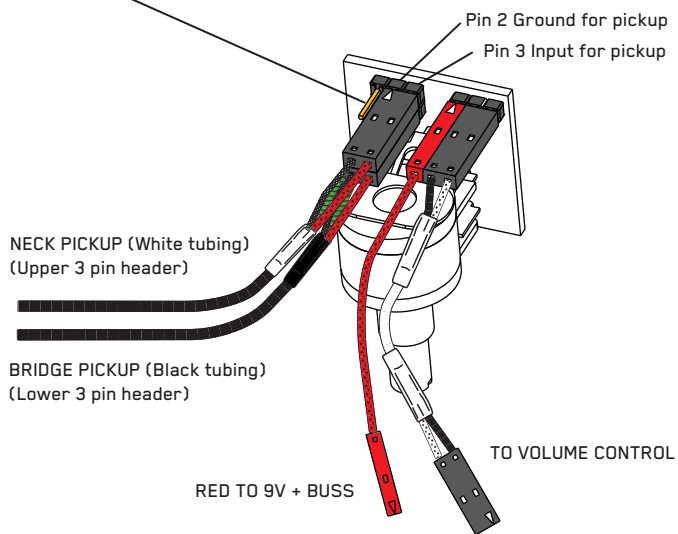

See any EMG-HZ Data Sheet
 for the coil / color codes

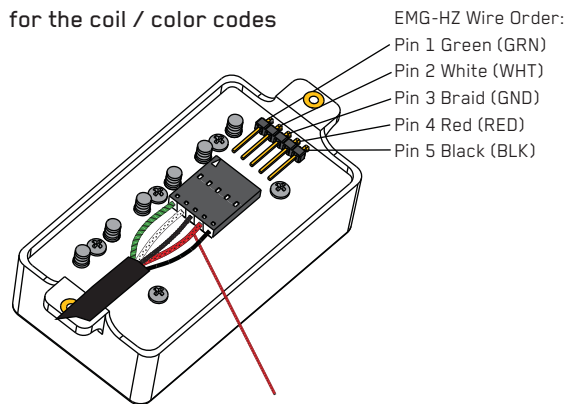

The RED Wire of the EMG-HZ Pickup is a coil wire. It is the signal output (hot) wire. **DO NOT** hook this wire to 9V+ or you will be sorry. Really sorry! If you are installing new EMG-HZ Passive Pickups refer to those data sheets.

Mixing EMG-HZ or other Passive Pickups and EMG Active Pickups:

Use either the Plug-in connector for an EMG-HZ (shown below) or hand solder any passive pickup to the PC Board using the solder pads provided. The EMG Active Pickup can be plugged into the chosen 3 pin input header or its cable can be soldered to the PC Board. The Red wire (9V+) of the EMG should be plugged onto Pin 1 of the ABC as shown or soldered to the buss connector as shown on page 3.

Diagram #2
EMG-HZ Plug-in Input (Bridge Pickup)
EMG Active Pickup Input (Neck Pickup)

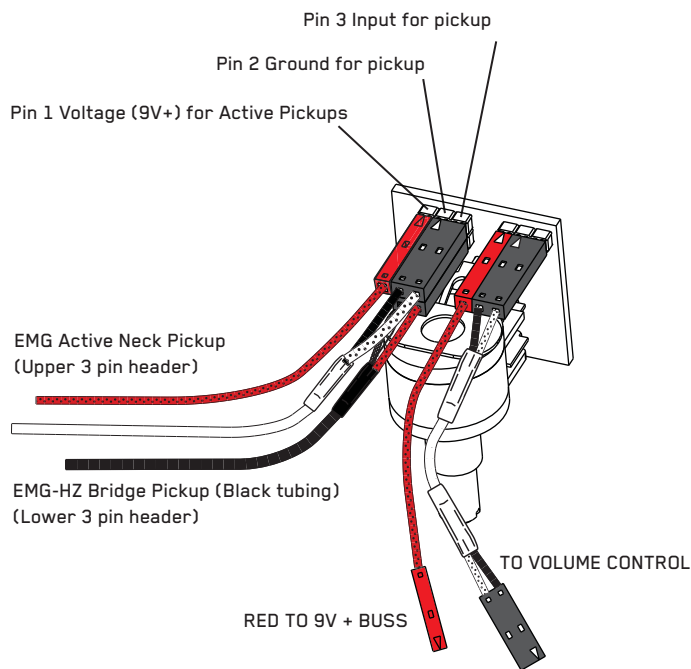
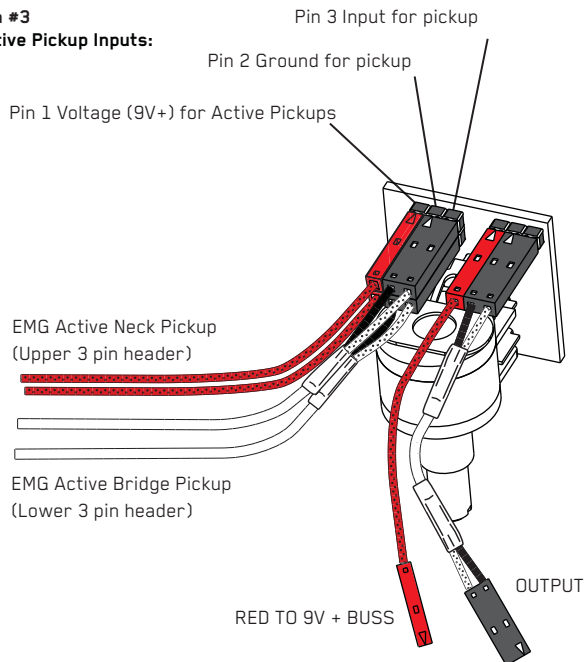

Diagram #3
EMG Active Pickup Inputs:



Soldered Inputs:

Using the existing EMG-HZ Cables:

If you use your existing EMG-HZ cables, use diagram #4 showing the cables hand soldered to the ABC Control. If you have a phase switch or coil-tap on one of the EMG-HZ Pickups the output of that switch should go to the BRG or NEK solder pad on the ABC Control, depending on which pickup is phased or tapped. The ground from that pickup should be soldered to the GND pad on the ABC Control.

Diagram #4
Soldered Input using EMG-HZ Pickups

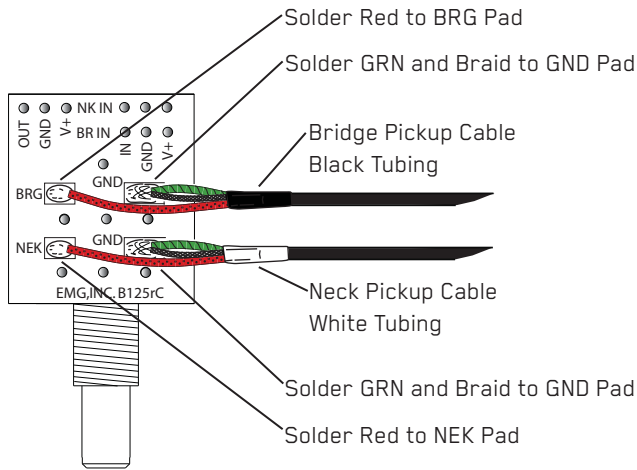

Using other passive pickups:

On the back side of the ABC Board there are 4 pads to solder to. Solder the signal wire (Hot) of your bridge pickup to the BRG Pad, and solder the ground wire (shield) of that pickup to the GND Pad.

Do the same for the Neck Pickup, Hot to the NEK Pad, and ground to the GND Pad.

If you have a phase switch or coil-tap on one of your pickups the output of that switch should go to the BRG or NEK solder pad on the ABC Control, depending on which pickup is phased or tapped. The ground from that pickup should be soldered to the GND pad on the ABC Control.

Diagram #5
Soldered Input using Passive Pickups

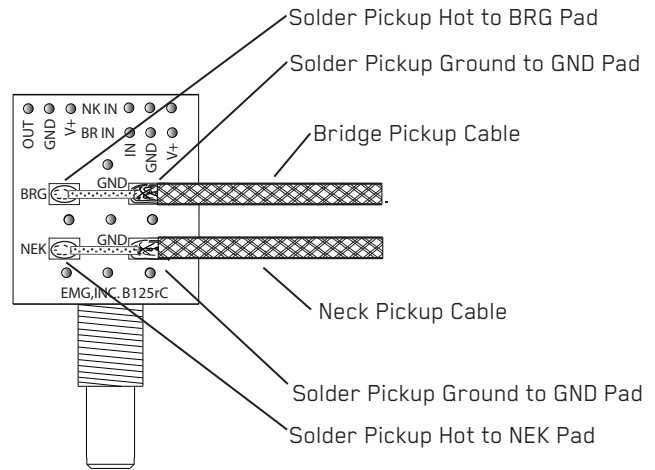

Using EMG Active Pickups:

On the back side of the ABC Board there are 4 pads to solder to. Solder the signal wire (Hot) of the bridge pickup to the BRG Pad and solder the shield (Braid) of the BRG Pickup to the GND Pad.

Do the same for the Neck Pickup. Solder the signal wire (Hot) to the NEK Pad and shield (Braid) to the GND Pad.

Powering up the pickups:

When you use the soldered inputs you will need to power the pickups with the power buss. Since your existing pickup cables don't have the connector for the power buss, simply use some needle nose pliers and pull out the V+ header and solder the RED Wires of the EMG Pickups to any of the pins on the header. Also, don't forget to solder the RED Wire of the battery clip to one of the header pins of the buss as well.

Diagram #6
Soldered Inputs using EMG Active Pickups

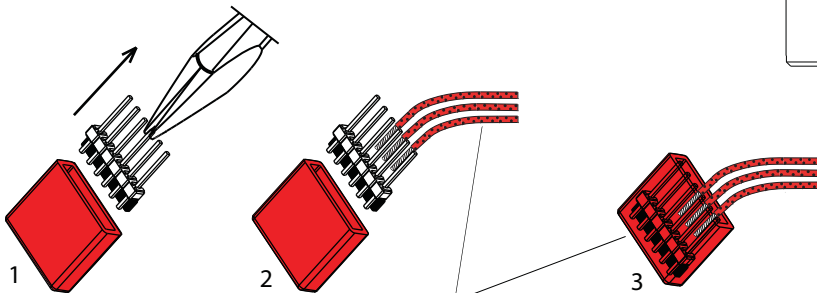
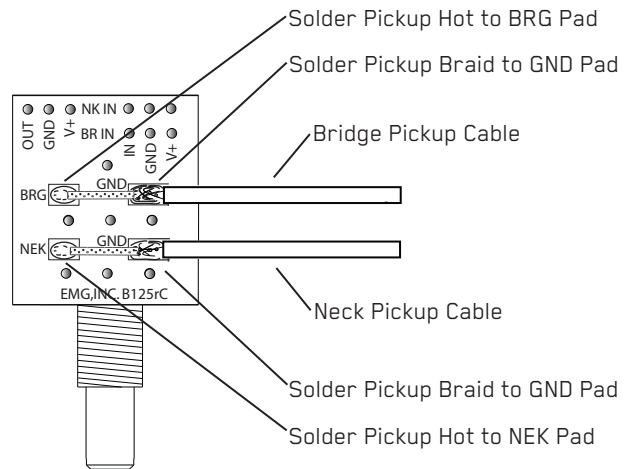

Solder RED wires from both EMG Pickups and the RED wire of the Battery Clip and re-insert the Header into the insulation cover

Output of the ABC Control:

The output of the ABC is a single channel signal that is sent to a master volume and active tone.

If you want a standard tone control (high end roll off) use the EMG-VLPF.

The following diagrams show any EMG "Active Tone" control being used i.e. VLPF, EXG, BTC Control, BTS Control, BQC Control, BQS Control, or any of EMG's OEM Controls like the B30EQ or B64EQ.

Preferred wiring order:

Below is a block diagram showing the preferred wiring order of the controls.

- 1) ABC Balance Control
- 2) Active tone control
- 3) Master Volume
- 4) Output jack

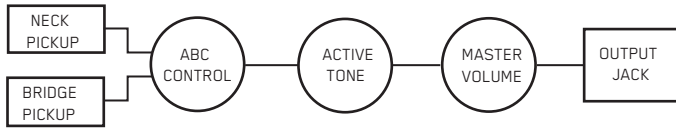

All of the EMG Active controls use the same color coded connector shown below.

Note: Reversed connector!
Make sure the colors of the wires match the color legend on the PC Board.

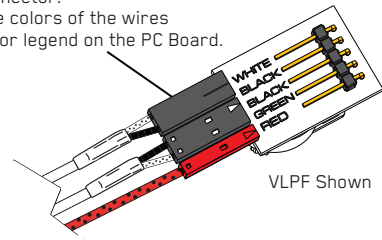

Color Code for EMG Active Tone controls and accessories.

- White: Input
- Black: Ground for Input
- Black: Ground for Output
- Green: Output
- Red: V+ Supply

Diagram #7 (preferred wiring order)

ABC Control / Active Tone / Master Volume / Output Jack

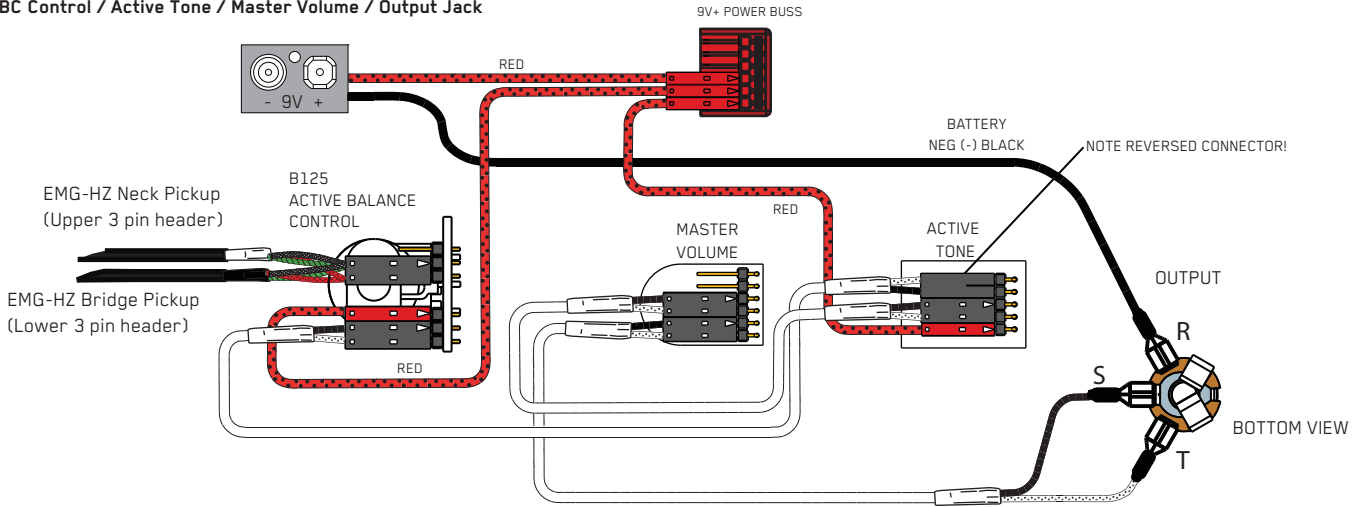

Alternate wiring order:

- 1) ABC Balance Control
- 2) Master Volume
- 3) Active Tone Control
- 4) Output jack

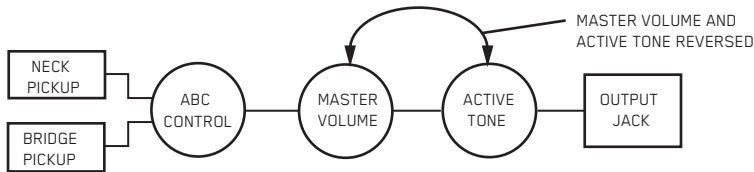

Diagram #8 (alternate wiring order)

ABC / Master Volume / Active Tone / Output Jack

