

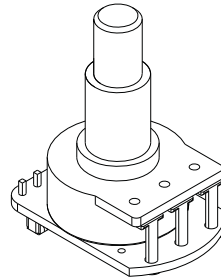

0230-0161A

PO BOX 4394
SANTA ROSA, CA
95402 USA

P (707) 525-9941
F (707) 575-7046
EMGPICKUPS.COM



SOLID SHAFT

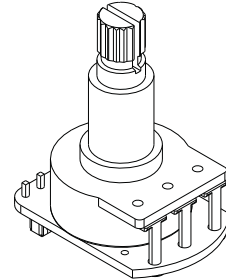

SPLIT SHAFT

INSTALLATION INFORMATION

EMG MODEL: B122 VOLUME CONTROL (ACTIVE PICKUP INPUT 25K OHM, BLACK PC BOARD) (PASSIVE PICKUP INPUT 500K OHM, GREEN PC BOARD)

GENERAL OPERATION

The B122 Volume control is included with each EMG Pickup and Pickup System. There are two versions, 25K Ohm for Active EMG's and 500K Ohm for EMG-HZ Passive Pickups. The 25K Ohm control has a black PC Board, the 500K has a green PC Board, both are Audio Taper. The wiring configuration is the same for both 25K and 500K Controls. There are 6 header pins, (3 pairs of signal and ground) two of the pairs are for in/out, the third pair is for tone send or daisy chaining. Examples are shown in the included diagrams. The B122 features plug-in compatibility with all EMG Pickup Systems by using .100 (2.54mm) standard pin spacing. You can solder to the input and output of the control by using the 4 solder pads on the PC Board if connectors are not available, 2 of the solder pads are for input/output and the other 2 pads are for ground.

Schematic Diagram: B122 Volume Control

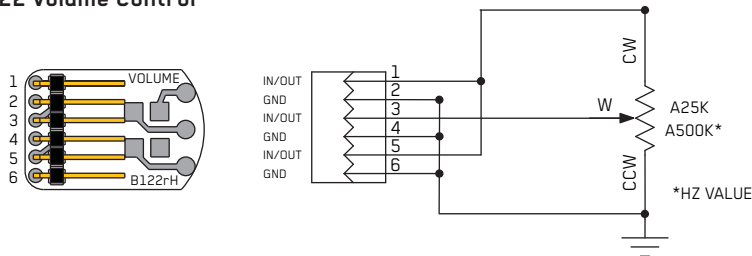

Dimensions: B122 Volume Control

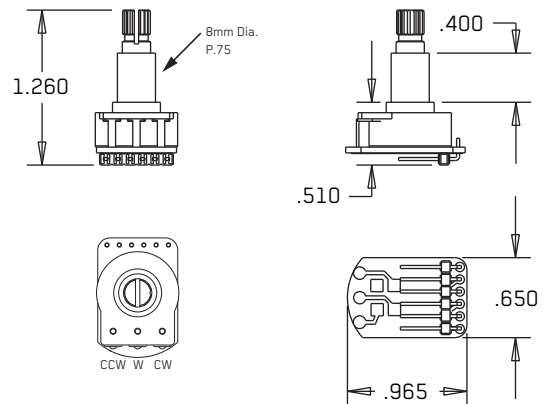

SCHEMATIC NOTES:

The Schematic diagram above shows how the B122 Volume control is configured. Pins 1 and 2 are the input or output of the CW (Clockwise) terminal of the control. Pins 3 and 4 are the input or output of the W (Wiper) terminal of the control. Pins 5 and 6 are duplicates of pins 1 and 2, the CW terminal (Clockwise). Pins 2, 4, and 6 go directly to ground, the CCW (Counter-Clockwise) terminal of the control

SOLDERING:

If you don't have connector cables, or prefer to solder to the control, terminals are provided. The diagram below shows the pads for soldering.

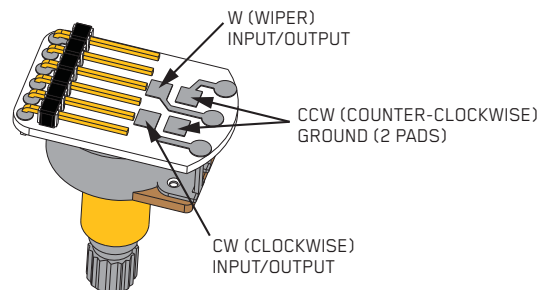

The EMG coax cables for wiring the guitar are a 2-pin pair. The signal or "Hot" wire is White, the Ground (Shield) wire is Black.

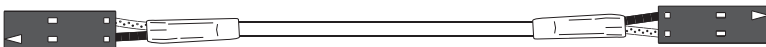

DIAGRAM NOTES:

Diagrams #1 and #2 perform the same function.
Diagram #1 shows the pickup input going into the CW pair (pins 1 and 2).
Diagram #2 shows the pickup input going to the CW pair (pins 5 and 6).
Again, pairs 1-2 and 5-6 are interchangeable, both are the CW pair.
Both diagrams show the output coming from the W pair (pins 3 and 4).

Instruments with one pickup:

It is recommended plugging the pickup onto either CW pair (pins 1-2 or 5-6) and taking the output of the Volume control from the W pair (pins 3-4) as in Diagram #1 or #2.

Master Volume with 2 pickups and a selection switch:

If you wish master volume control when the selection switch is in the "both" position, input the pickups onto either CW (Clockwise) pair (pins 1-2 or 5-6) and take the output from the W (Wiper) Pair, pins 3-4, as in Diagrams #1 or #2

Diagram #1

Pickup input on pins 1 and 2 (CW Terminal)
Output on pins 3 and 4 (W Terminal)

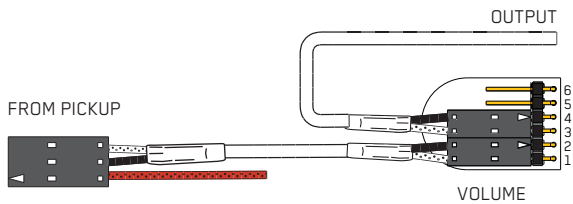
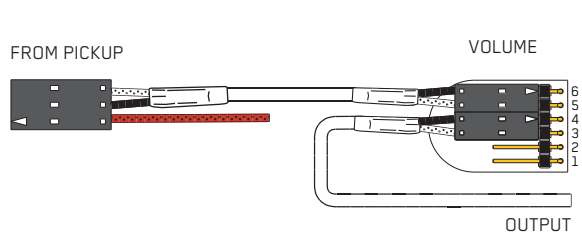

Diagram #2

Pickup input on pins 5 and 6 (CW Terminal)
Output on pins 3 and 4 (W Terminal)



Independent Volume with 2 pickups and a selection switch:

If you wish independent volume control when the selection switch is in the "both" position, input the pickups to the W (Wiper) pair (pins 3-4) and take the output from either CW pair (pins 1-2 or 5-6) as in Diagrams #3 or #4.

Sending the pickup input to the wiper (W Terminal) is common in installations that have two pickups but no selection switch, it allows the volume control of each pickup to work independent of the other. A Volume/Volume/Master Tone setup is a perfect example of this. If you have a selection switch, using the W pair (pins 3 and 4) allows each volume control to work independently in the "both" pickup switch position.

Diagram #3

Pickup in on pins 3 and 4 (W Terminal)
Output on pins 5 and 6 (CW Terminal)

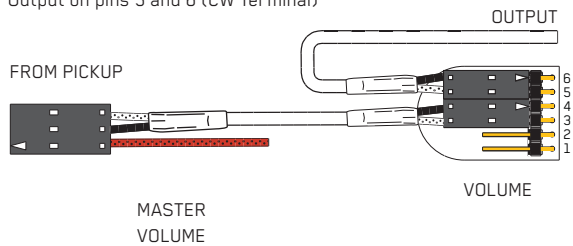
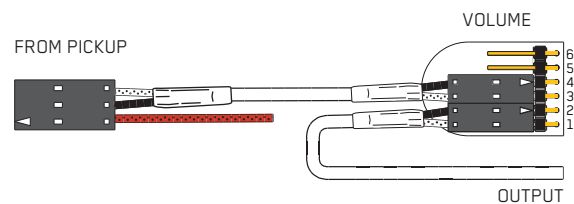

Diagram #4

Pickup in on pins 3 and 4 (W Terminal)
Output on pins 1 and 2 (CW Terminal)



Independent volume with 2 pickups and no selection switch:

Sending the pickup input to the wiper (W Terminal) is common in installations that have 2 pickups but no selection switch. This allows the volume control of each pickup to work independent of the other. A Volume/Volume/Master Tone setup is a perfect example of this. Pickup input to the W pair (pins 3 and 4) allows each volume control to work independently.

